

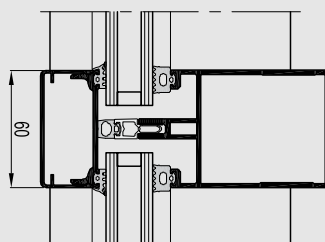

© Rob Parrish retains Worldwide Copyright to all the photography.
The licenced Photography may not be issued to a third party without permission.

CW 60

Solution for heavy glass panes

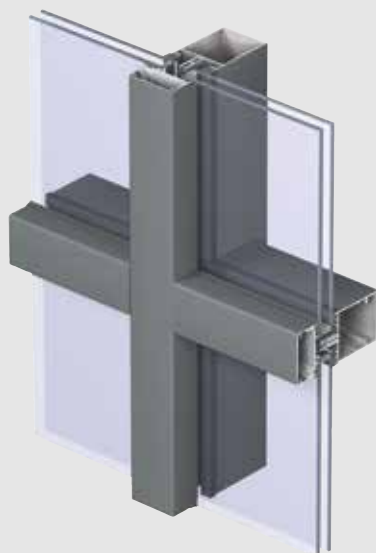



Concept Wall® 60 is an excellent thermally insulated curtain wall system for robust structure of large glass surfaces, that answers even to the specific needs of sloped or curved constructions. This modular system is designed with intelligently reinforced profiles, allowing to install heavy weight glass panels.







The CW 60 concept meets the highest requirements in water- and air tightness, wind load resistance and thermal insulation. The glazing is secured by a rebate height of 25 mm. The ability to hold up to 62 mm of glass thickness makes it possible to integrate triple glazing.

This curtain wall system is standard available in 4 different aesthetical outside appearances. In addition, CW 60 is made up of an extensive profile range, and facilitates the integration of all types of windows including attic windows.



TECHNICAL CHARACTERISTICS			
			
Style variants	CW 60 functional	CW 60-HI ultimate thermal comfort	CW 60-SC structural clamped glazing
Inside visible width	60 mm	60 mm	60 mm
Outside visible width	60 mm	60 mm	silicon joint or EPDM gasket of 20mm width
Depth mullions	from 79 to 268 mm	from 79 to 268 mm	from 79 to 268 mm
Depth transoms	from 78.4 to 204.4 mm	from 78.4 to 204.4 mm	from 78.4 to 204.4 mm
Glass thickness	6 to 62 mm	22 to 62 mm	27 to 63 mm
Types of vents	all Reynaers systems THW and POW (glass from 24 to 32 mm)	all Reynaers systems vents of CS 77 and CS 86-HI preferred	all Reynaers systems THW and POW (glass from 27 to 34 mm)

TECHNICAL CHARACTERISTICS			
			
Style variants	CW 60-SG structural sealed glazing	CW 60-HL functional	CW 60-RA
Inside visible width	60/88 mm	60 mm	60 mm
Outside visible width	EPDM gasket of 27mm width	vertical : 30 mm joint horizontal : 60 mm pressure plate	60 mm
Depth mullions	from 79 to 268 mm	from 79 to 268 mm	from 79 to 268 mm
Depth transoms	from 78.4 to 204.4 mm	from 78.4 to 204.4 mm	from 78.4 to 204.4 mm
Glass thickness	24 to 36 mm	22 to 48 mm	6 to 45 mm
Types of vents	not applicable	not applicable	attic window

PERFORMANCES						
	ENERGY					
	Thermal insulation ⁽¹⁾ EN 13947	Specific test per profile combination, please contact your Reynaers Aluminium fabricator				
	COMFORT					
	Acoustic performance ⁽²⁾ EN ISO 140-3; EN ISO 717-1	Rw (C;Ctr) = 34 (-1;-4) dB/47 (-2;-5) dB, depending on the glazing type				
	Air tightness, max. test pressure ⁽³⁾ EN 12153; EN 12152	A4 (600 Pa)				
	Water tightness ⁽⁴⁾ EN 12155; EN 12154	R4 150	R5 300	R6 450	R7 600	RE 1200
	Wind load resistance, max. test pressure ⁽⁵⁾ EN 12179; EN 13116	2400 Pa				
	Resistance against impact EN 14019	E5 / I5				

This table shows possible classes and values of performances, which can be achieved for specific configurations and opening types: contact Reynaers for further information.

The values indicated in red are the ones relevant to this system.

(1) The Uf-value measures the heat flow. The lower the Uf-value, the better the thermal insulation of the frame.

(2) The sound reduction index (Rw) measures the capacity of the sound reduction performance of the frame.

(3) The air tightness test measures the volume of air that would pass through a closed window at a certain air pressure.

(4) The water tightness testing involves applying a uniform water spray at increasing air pressure until water penetrates the window.

(5) The wind load resistance is a measure of the profile's structural strength and is tested by applying increasing levels of air pressure to simulate the wind force. There are up to five levels of wind resistance (1 to 5) and three deflection classes (A,B,C). The higher the number, the better the performance.